

Operation Manual

<English version>

Thank you very much for purchasing **X** series printer



- In order to use this product correctly and safely and understand this product's capability, please read this manual carefully.
- Forbidden to fully or partially copy this manual.
- This manual is subjected to change without notice.
- Please contact us if you find any mistakes.

17th April, 2015

Version: V1.0

Contents

Chapter 1: Safety Precaution.....3

Chapter 2: Preparation and Procedures for Assembling ...5

Chapter 3: Machine Structure and Accessories.....6

Chapter 4: Basic Operation.....11

Chapter 5: Technical Specification.....12

1.1 Important Safety Measures

Please read the following instructions before using the printer. Follow cautions and instructions which are labeled on the printer:

- (7) Do NOT block the opening on the top of the printer.
- (8) Do NOT insert any object into the printing platform. Prevent spilling liquid onto the printer.
- (9) ONLY 220V can be applied.
- (10) Connect all the power cord to a single socket extension. Avoid sharing the socket with the devices which will be on and off frequently.
- (11) Avoid using the socket with self-timer control and with the switch on the wall.
- (12) Keep your computer away from any device which will release electro-magnetic field, such as wireless phone.
- (13) Do NOT use damaged power cord.
- (14) If using an extra power cord, keep in mind that the total ampere of this device does not exceed the assigned ampere of the power. Also, the total ampere of all the device which connect to single socket cannot exceed the assigned ampere.
- (15) Do NOT try to repair the printer.

When encounter the following circumstance, disconnect the power and contact your local distributor for support:

- 1) Power cord or plug is damaged;
- 2) Liquid is spilled onto the printer;
- 3) The printer falls down or the surface is broken;
- 4) Printer does not run normally.

1.2 Handling Printer Caution

- 1) Do NOT move the carriage when the power is on.
- 2) Always use the power switch to turn on or off the printer. Do NOT try to remove the data cable or the power cord when the machine is on.
- 3) Make sure the carriage is stabilized in the origin position during transport.

1.3 Handling Ink Tank Caution

- 1) Please store ink tanks at the place where children cannot reach. Do NOT let children touch the ink tank.
- 2) If ink is spilled into eyes, immediately wash with water and see your doctor.
- 3) Do NOT shake the ink tank, this may cause leakage.
- 4) Please often check the ink content in main ink tank, avoid unnecessary loss due to lack of ink.
- 5) Please often check the waste ink tank and replace it in time when it becomes full.

1.4 Printer Installation Site

- 1) Place the printer on a level floor otherwise it will not operate normally.
- 2) Avoid placing the printer in the area with huge change of temperature and humidity. Do NOT expose the printer to direct sunlight or heat. Avoid placing the printer in any possible shaking or vibrating area.
- 3) Leave enough space around the printer to ensure normal ventilation.
- 4) Place the printer close to the power socket so that power cord can be removed and plugged easily.

Chapter 2 Preparation and Procedures for Assembling

2.1 Environment requirement

Keep the room temperature between 20—30°C, and the humidity between 40—60%. Air conditioner and humidifier may require. Keep a distance from strong radiation field. The floor must be level.

Site Requirement: L4845mm、W1070mm、H1585mm

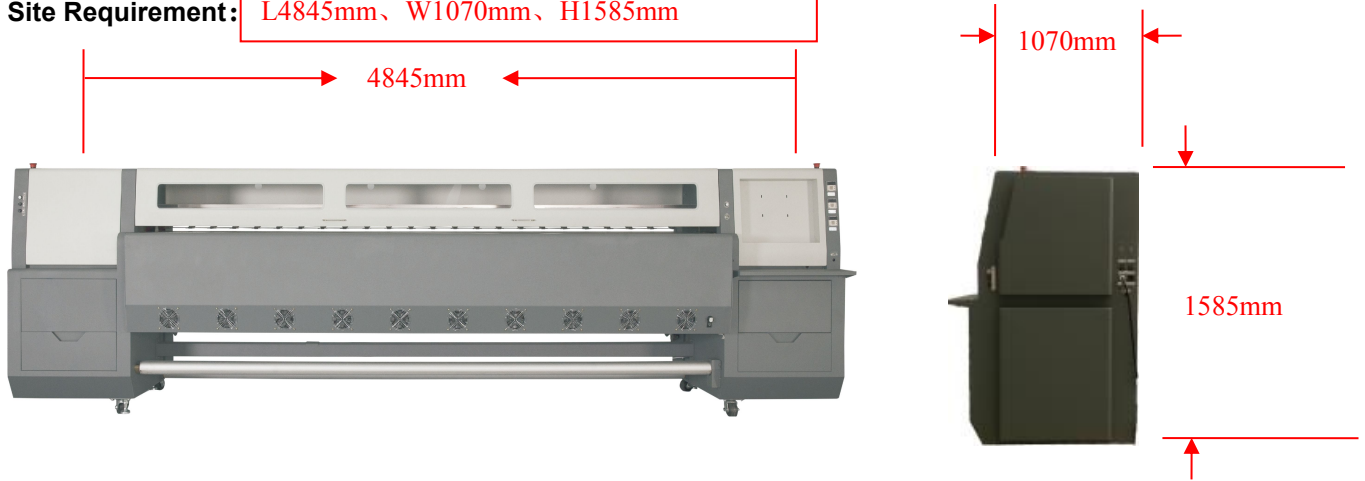

Leave at least 900mm of space around the machine.

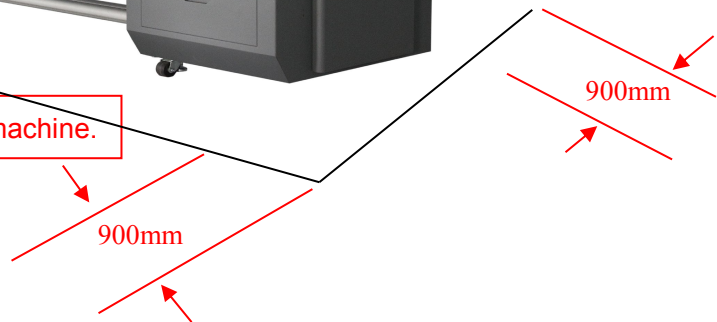

2.2 Electrical requirement

The printer only supports AC 220V. A transformer is needed if the area is using AC110V.

- ⚠ The printer must be well grounded (the grounded voltage should be less than 0.3V, and the grounded resistance should be less than 3Ω).
- ⚠ UPS and voltage stabilizer is highly recommended
- ⚠ **Note:** The power cable for the heater (Total Power 600W, 25A). The power source must not less than 25A.

Note: The total power consumption of the machine cannot be higher than the assigned power on the socket.

3. 1 Machine Structure:

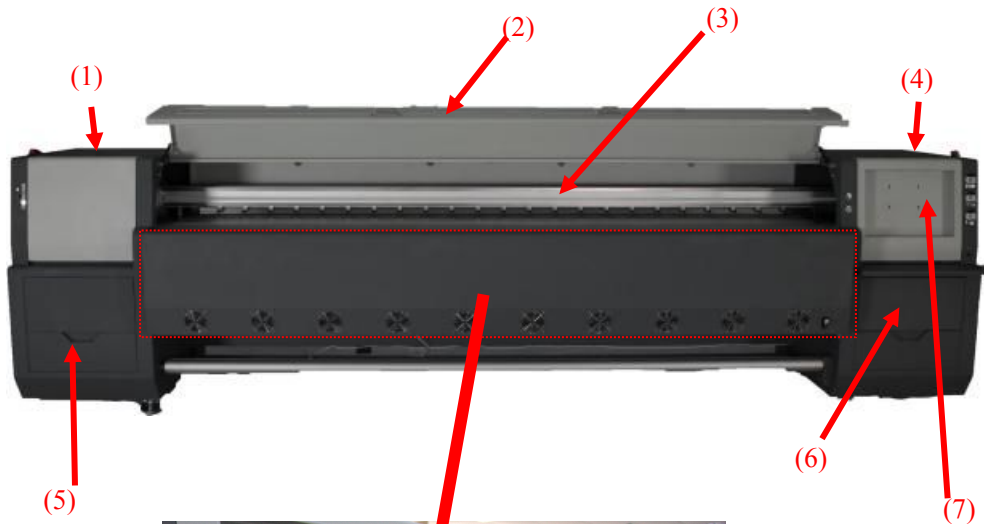

- (1) Left machine box
- (2) Cover
- (3) Girder
- (4) Right machine box
- (5) Waste ink tank area
- (6) Main ink tank area
- (7) Monitor position

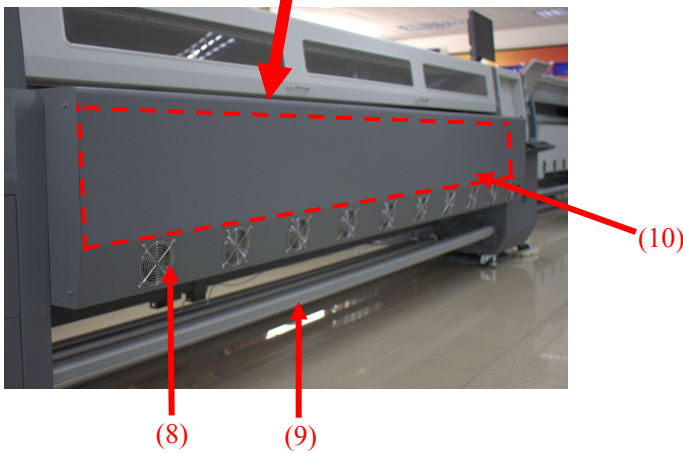

- (8) Cooling fan
- (9) Takeup bar
- (10) IR heating system

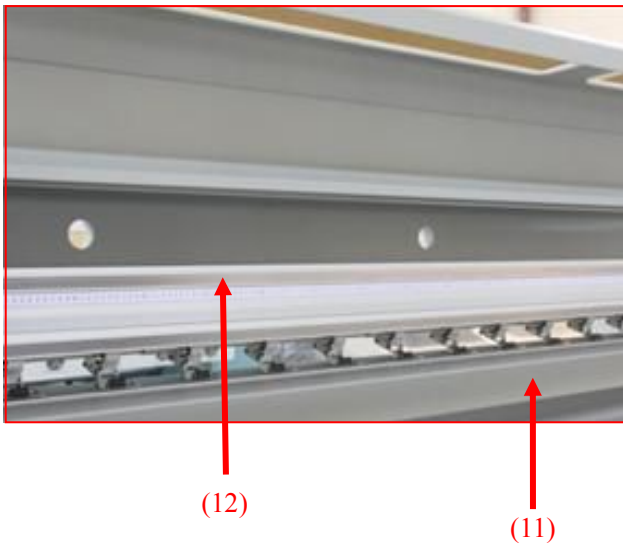

- (11) Platen
- (12) Rail

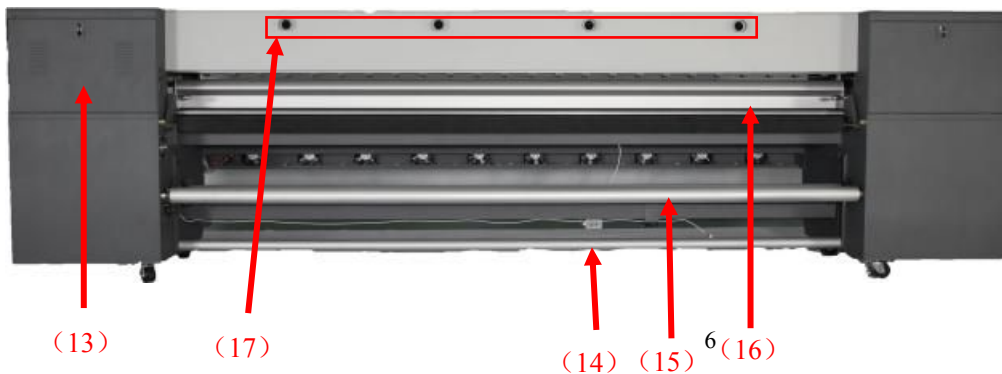

- (13) Electronic position
- (14) Tension bar
- (15) Feeding bar
- (16) Girder
- (17) Ventilation outlet



- (18) Girder
- (19) Feeding bar B
- (20) Tension bar
- (21) Feeding bar A

3. 2 Interface and Switches:

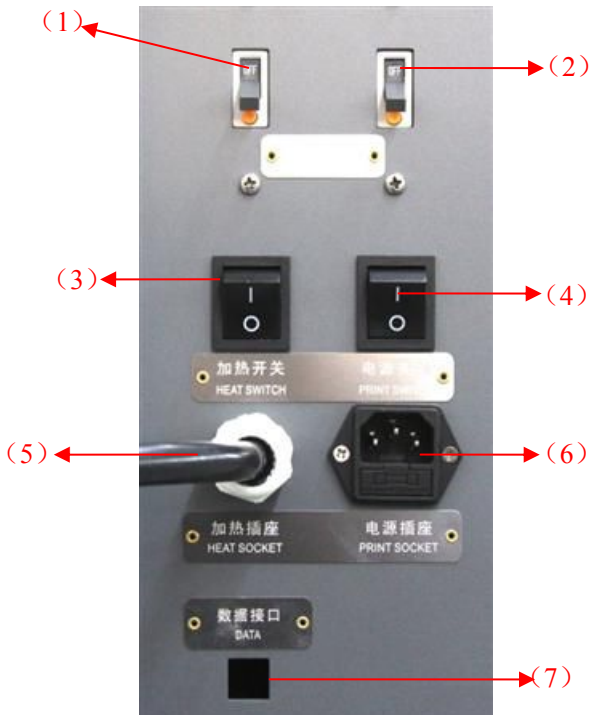

- (1) Vacuum and heater safety switch
- (2) Printer safety switch
- (3) Vacuum and heater main switch
- (4) Printer main switch
- (5) Vacuum and heater power cable
- (6) Printer power socket
- (7) USB data port

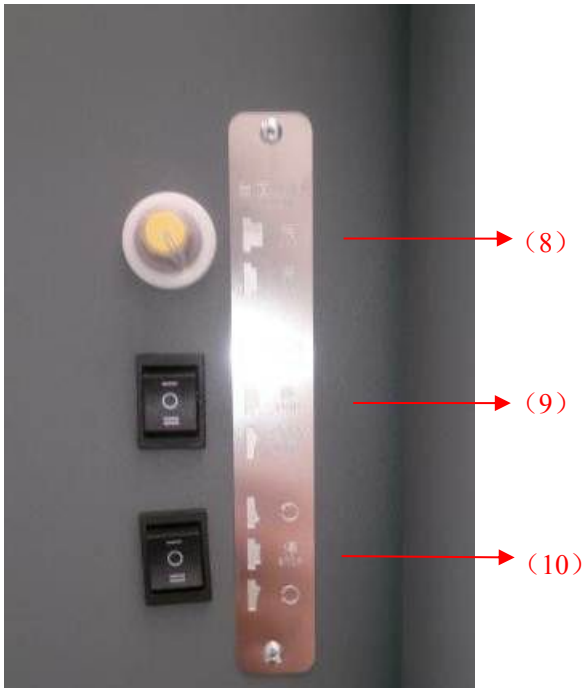

- (8) Platen vacuum (Adjustable)
- (9) Takeup Manual/Auto switch
- (10) Takeup direction switch

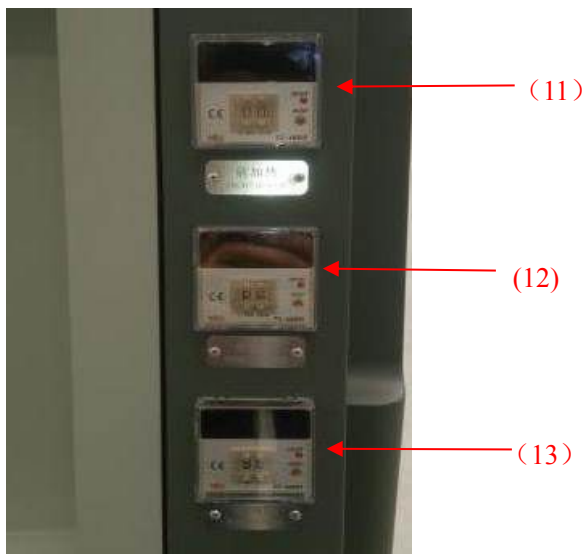

- (11) Front Temp Controller
- (12) Middle Temp Controller
- (13) Rear Temp Controller

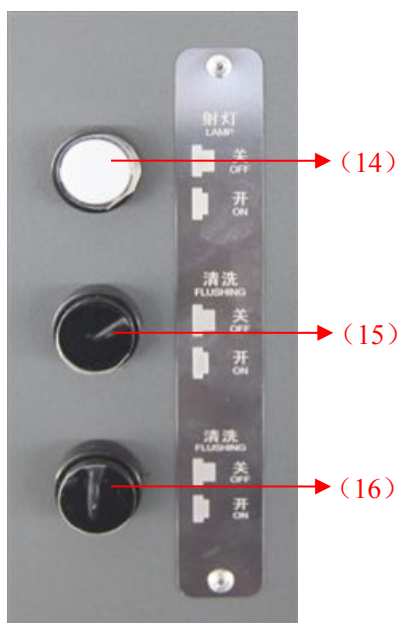

- (14) Lamp
- (15)、(16) Flush buttons

Note:

Connect flush tubes to the ink tube, and then press 15,16 together to flush printhead by solvent.

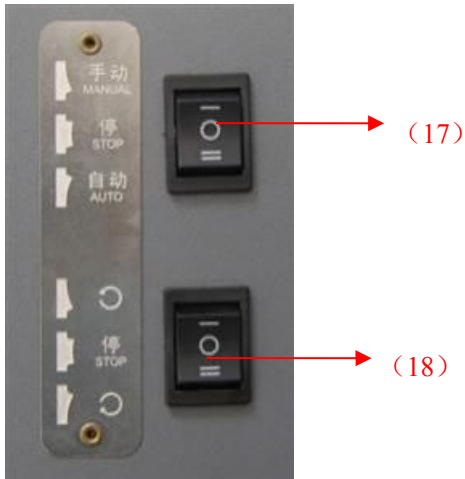

- (17) Feeding Manual/Auto switch
- (18) Feeding direction switch

Ink Supply System:

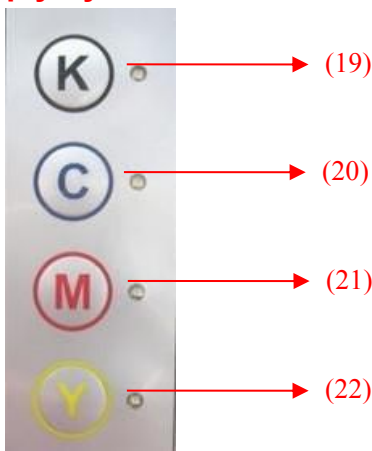

- (19) K individual color purging
- (20) C individual color purging
- (21) M individual color purging
- (22) Y individual color purging



- (23) Emergency stop

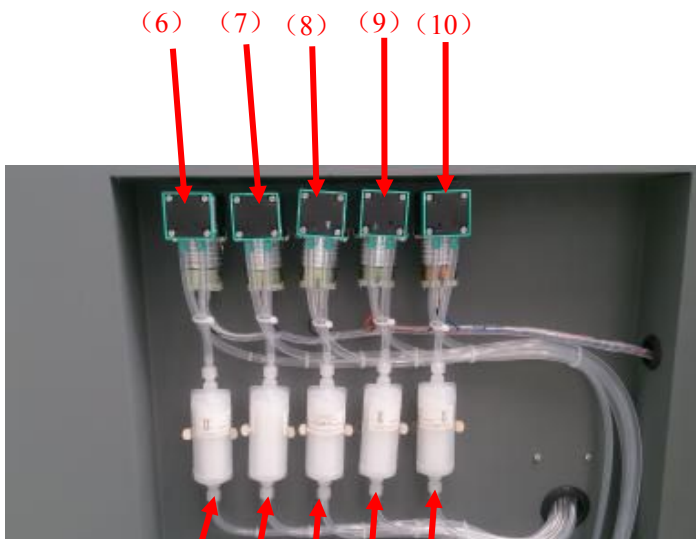

- (1) K filter
- (2) C filter
- (3) M filter
- (4) Y filter
- (5) Solvent filter
- (6) K ink pump
- (7) C ink pump
- (8) M ink pump
- (9) Y ink pump
- (10) Solvent pump

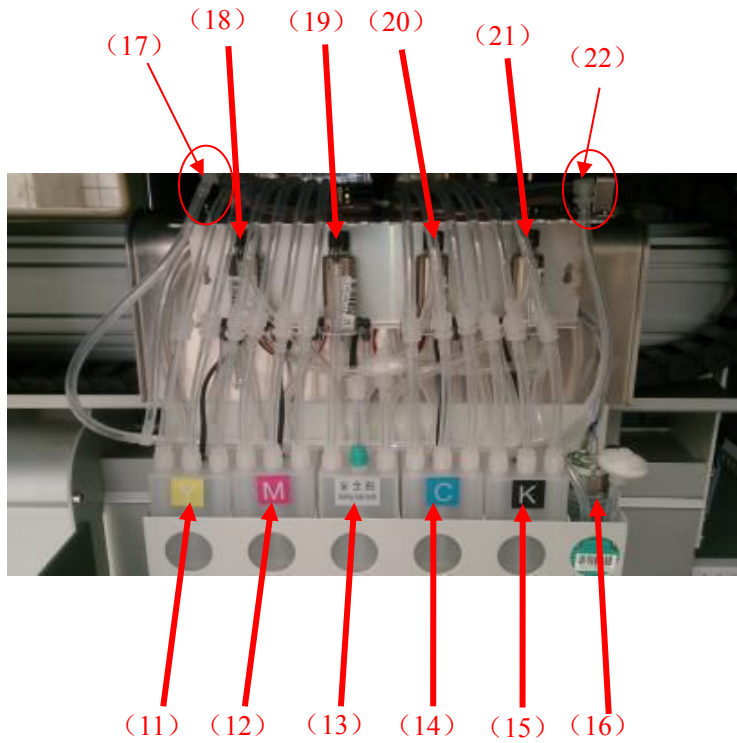

- (11) Y subtank
- (12) M subtank
- (13) Safety subtank
- (14) C subtank
- (15) K subtank
- (16) Air pump
- (17) Solvent tube
- (18) Y elec mag. valve
- (19) M elec mag. valve
- (20) C elec mag. valve
- (21) K elec mag. valve
- (22) Solvent tube



Note: Connect the solvent tube to the ink tube before start solvent flushing !



After finish solvent flushing, empty the solvent in the tube. Cap the solvent tube.

Feeding Instruction:

1) Load the media on the support bar:

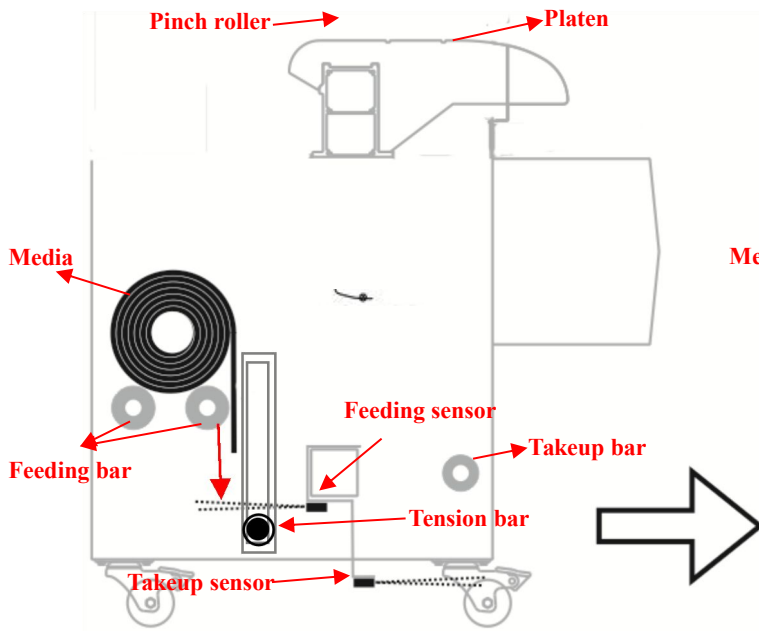

2) Takeup instruction: Pull the media in the direction of the red arrow!

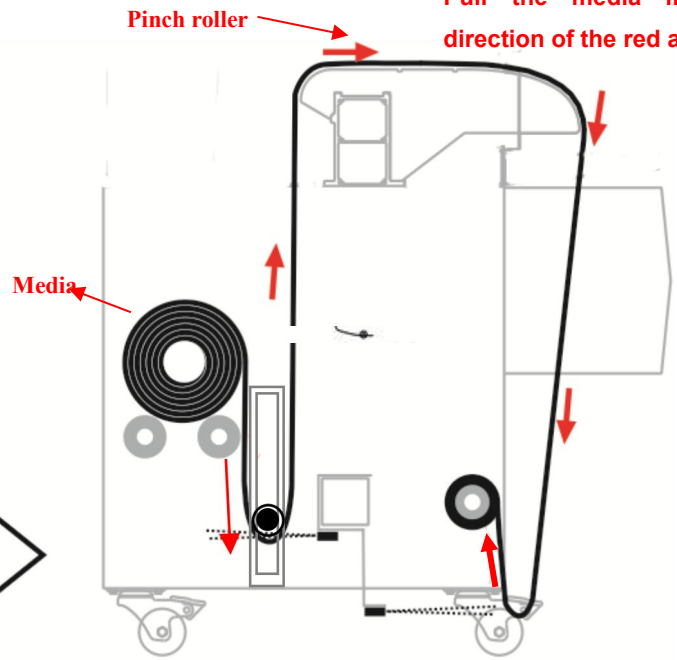

Auto feeding setting:

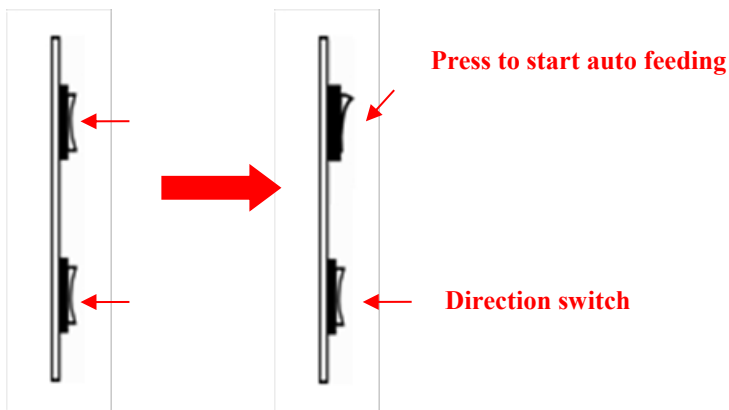

Specification		
Model	X	
Max. printing width	3200mm	
Max. media width	3300mm	
Printhead Type	32712X	
	SPT510-50PL	
	12 heads	
Ink	Type	Solvent or Eco-solvent
	Color	C,M,Y,K
	Volume	1 liter or 5 liters main tank
	Ink supply system	Ink level sensor. Auto-pumping
Media	Width	3300mm
	Type	PVC banner, Flex, etc
Feeding System	Single or double feeding bar. (Max weight 80kg)	
Ph. Cleaning System	Individual color purging	
Heating System	Back, middle, front, and extra heater.	
Clamp	Equipped	
Printhead Height	Adjustable distance from 2mm~6mm.	
Input Voltage	AC 220V/230V, 50Hz/60Hz	
Printer Dimension/Weight	L4845xW1070xH1585mm / 650 kg	
Package Dimension/Weight	L5000xW1200xH1900mm / 903 Kg	

~END~